

## **SPLIT-TYPE AIR CONDITIONERS**

### **INDOOR UNIT**

**MSZ-AP25VG MSZ-AP35VG MSZ-AP42VG MSZ-AP50VG**



OPERATING INSTRUCTIONS  
BEDIENUNGSANLEITUNG  
NOTICE D'UTILISATION  
BEDIENINGSINSTRUCTIES  
MANUAL DE INSTRUCCIONES  
LIBRETTO D'ISTRUZIONI  
ΟΔΗΓΙΕΣ ΛΕΙΤΟΥΡΓΙΑΣ  
INSTRUÇÕES DE OPERAÇÃO  
BETJENINGSVEJLEDNING  
BRUKSANVISNING  
ÇALIŞTIRMA TALİMATLARI  
РЪКОВОДСТВО ЗА ЕКСПЛОАТАЦИЯ  
INSTRUKCJA OBSŁUGI  
BRUKSANVISNING  
KÄYTTÖOHJEET  
NÁVOD K OBSLUZE  
NÁVOD NA OBSLUHU  
HASZNÁLATI ÚTMUTATÓ  
NAVODILA ZA UPORABO  
INSTRUCȚIUNI DE UTILIZARE  
KASUTUSJUHEND  
LIETOŠANAS INSTRUKCIJAS  
NAUDOJIMO INSTRUKCIJA  
UPUTE ZA UPORABU  
UPUTSTVA ZA RUKOVANJE

**English**

**Deutsch**

**Français**

**Nederlands**

**Español**

**Italiano**

**Ελληνικά**

**Português**

**Dansk**

**Svenska**

**Türkçe**

**Български**

**Polski**

**Norsk**

**Suomi**

**Čeština**

**Slovenčina**

**Magyar**

**Slovenščina**

**Română**

**Eesti**

**Latviski**

**Lietuviškai**

**Hrvatski**

**Srpski**



# Manual Download



<http://www.mitsubishielectric.com/ldg/ibim/>

- EN** This manual is brief version. Go to the above website and choose language to download full version OPERATING INSTRUCTIONS and INSTALLATION MANUAL.
- DE** Diese Anleitung ist eine Kurzversion. Besuchen Sie die oben stehende Website und wählen Sie die Sprache aus, um die vollständige Version von BEDIENUNGSANLEITUNG und INSTALLATIONSANLEITUNG herunterzuladen.
- FR** Ce manuel est une version abrégée. Rendez-vous sur le site Web ci-dessus et choisissez la langue pour télécharger la version complète de la NOTICE D'UTILISATION et du MANUEL D'INSTALLATION.
- NL** Deze handleiding is een beknopte versie. Ga naar de bovenstaande website en kies een taal om de volledige BEDIENINGSINSTRUCTIES en INSTALLATIEHANDLEIDING te downloaden.
- ES** Este manual es una versión abreviada. Visite el anterior sitio web y elija el idioma para descargar la versión completa del MANUAL DE INSTRUCCIONES y del MANUAL DE INSTALACIÓN.
- IT** Questo manuale è una versione sintetica. Visitare il sito Web indicato sopra e selezionare la lingua per scaricare la versione integrale del LIBRETTO D'ISTRUZIONI e del MANUALE PER L'INSTALLAZIONE.
- EL** Αυτό το εγχειρίδιο χρήσης είναι συνοπτικό. Μεταβείτε στον παραπάνω ιστότοπο και επιλέξτε γλώσσα, για να κατεβάσετε την πλήρη έκδοση των ΟΔΗΓΙΩΝ ΛΕΙΤΟΥΡΓΙΑΣ και του ΕΓΧΕΙΡΙΔΙΟΥ ΕΓΚΑΤΑΣΤΑΣΗΣ.
- PT** Este manual é uma versão abreviada. Aceda ao site Web acima indicado e seleccione o idioma pretendido para descarregar a versão completa das INSTRUÇÕES DE OPERAÇÃO e do MANUAL DE INSTALAÇÃO.
- DA** Denne vejledning er en forkortet udgave. Besøg ovennævnte websted, og vælg sproget for at hente den fulde version af BETJENINGSVEJLEDNINGEN og INSTALLATIONSHÅNDBOGEN.
- SV** Denna handbok är en kortversion. Gå till den ovannämnda webbplatsen och välj språk för att ladda ned fullständig version av BRUKSANVISNING och INSTALLATIONSANVISNING.
- TR** Bu kılavuz kısa versiyondur. Yukarıdaki web sitesine gidin ve ÇALIŞTIRMA TALİMATLARI ile TESIS ETME KILAVUZU dosyalarının tam versiyonlarını indirmek için dil seçimini yapın.
- BG** Това ръководство е съкратена версия. Посетете горепосочения уебсайт и изберете език, за да изтеглите пълна версия на РЪКОВОДСТВОТО ЗА ЕКСПЛОАТАЦИЯ и РЪКОВОДСТВО ЗА МОНТАЖ.
- PL** Niniejsza instrukcja to wersja skrócona. Odwiedź powyższą stronę internetową i wybierz język, aby pobrać pełną wersję INSTRUKCJI OBSŁUGI i INSTRUKCJI MONTAŻU.
- NO** Denne håndboken er kortversjonen. Gå til nettstedet over og velg språk for å laste ned fullstendig versjon av BRUKSANVISNINGEN og INSTALLASJONSHÅNDBOKEN.
- FI** Tämä opas on lyhyt versio. Siirry yllä mainitulle verkkosivustolle ja valitse kieli, niin voit ladata KÄYTTÖOHJEIDEN ja ASENNUSOPPAAN koko version.
- CS** Tato příručka je zkrácená verze. Přejdete na webovou stránku nahoře a vyberte jazyk ke stáhnutí plné verze NÁVODU K OBSLUZE a INSTALAČNÍ PŘÍRUČKY.
- SK** Toto je stručná verzia návodu. Prejdite na vyššie uvedenú webovú stránku a zvolte si jazyk úplnej verzie NÁVODU NA OBSLUHU a NÁVODU NA INŠTALÁCIU, ktorý si chcete prevziať.
- HU** Ez a kézikönyv egy rövidített verzió. Látogasson el a fenti webhelyre, és a nyelv kiválasztása után töltsse le a HASZNÁLATI ÚTMUTATÓ és a TELEPÍTÉSI KÉZIKÖNYV teljes verzióját.
- SL** Ta priročnik je samo kratka različica. Če želite pridobiti celotno različico NAVODIL ZA UPORABO in NAMESTITVENI PRIROČNIK, obiščite zgornje spletno mesto, izberite jezik in prenesite ustrezno datoteko.
- RO** Acest manual este o versiune simplificată. Accesați site-ul web de mai sus și alegeți limba pentru a descărca versiunea completă a INSTRUCȚIUNILOR DE UTILIZARE și a MANUALULUI DE INSTALARE.
- ET** See on juhendi lühiversioon. KASUTUS- ja PAIGALDUSJUHENDI täisversiooni allalaadimiseks minge eelnimetatud veebisaidile ja valige keel.
- LV** Šī rokasgrāmata ir saīsināta versija. Lai lejupielādētu pilnīgu LIETOŠANAS INSTRUKCIJAS un MONTĀŽAS ROKASGRĀMATAS versiju, apmeklējiet iepriekš norādīto tīmekļa vietni un izvēlieties attiecīgo valodu.
- LT** Šiame vadove pateikta trumpoji versija. Apsilankykite minėtoje interneto svetainėje, pasirinkite kalbą ir parsisiųskite pilnas NAUDOJIMO INSTRUKCIJOS ir MONTAVIMO VADOVAS versijas.
- HR** Ovaj je priručnik kratka inačica. Posjetite gore navedeno mrežno mjesto i izaberite jezik kako biste preuzeli punu inačicu UPUTA ZA UPORABU i PRIRUČNIKA ZA POSTAVLJANJE.
- SR** Ovaj priručnik je skraćena verzija. Posetite gorenaveden veb-sajt i izaberite jezik da biste preuzeli kompletnu verziju UPUTSTVA ZA RUKOVANJE i UPUTSTVA ZA UGRADNJU.

# SAFETY PRECAUTIONS

## Meanings of symbols displayed on indoor unit and/or outdoor unit

	<b>WARNING</b> (Risk of fire)	This unit uses a flammable refrigerant. If refrigerant leaks and comes in contact with fire or heating part, it will create harmful gas and there is risk of fire.
	Read the OPERATING INSTRUCTIONS carefully before operation.	
	Service personnel are required to carefully read the OPERATING INSTRUCTIONS and INSTALLATION MANUAL before operation.	
	Further information is available in the OPERATING INSTRUCTIONS, INSTALLATION MANUAL, and the like.	

- Since rotating parts and parts which could cause an electric shock are used in this product, be sure to read these "Safety Precautions" before use.
- Since the cautionary items shown here are important for safety, be sure to observe them.
- After reading this manual, keep it together with the installation manual in a handy place for easy reference.

### Marks and their meanings

- WARNING :** Incorrect handling could cause serious hazard, such as death, serious injury, etc. with a high probability.
- CAUTION :** Incorrect handling could cause serious hazard depending on the conditions.

### Meanings of symbols used in this manual

- : Be sure not to do.
- : Be sure to follow the instruction.
- : Never insert your finger or stick, etc.
- : Never step onto the indoor/outdoor unit and do not put anything on them.
- : Danger of electric shock. Be careful.
- : Be sure to disconnect the power supply plug from the power outlet.
- : Be sure to shut off the power.
- : Risk of fire.
- : Never touch with wet hand.
- : Never splash water on the unit.





EN

<b>WARNING</b>	
	<p><b>Do not connect the power cord to an intermediate point, use an extension cord, or connect multiple devices to a single AC outlet.</b></p> <ul style="list-style-type: none"> <li>• This may cause overheating, fire, or electric shock.</li> </ul>
	<p><b>Make sure the power plug is free of dirt and insert it securely into the outlet.</b></p> <ul style="list-style-type: none"> <li>• A dirty plug may cause fire or electric shock.</li> </ul>
	<p><b>Do not bundle, pull, damage, or modify the power cord, and do not apply heat or place heavy objects on it.</b></p> <ul style="list-style-type: none"> <li>• This may cause fire or electric shock.</li> </ul>
	<p><b>Do not turn the breaker OFF/ON or disconnect/connect the power plug during operation.</b></p> <ul style="list-style-type: none"> <li>• This may create sparks, which can cause fire.</li> <li>• After the indoor unit is switched OFF with the remote controller, make sure to turn the breaker OFF or disconnect the power plug.</li> </ul>
	<p><b>Do not expose your body directly to cool air for a prolonged length of time.</b></p> <ul style="list-style-type: none"> <li>• This could be detrimental to your health.</li> </ul>
	<p><b>The unit should not be installed, relocated, disassembled, altered, or repaired by the user.</b></p> <ul style="list-style-type: none"> <li>• An improperly handled air conditioner may cause fire, electric shock, injury, or water leakage, etc. Consult your dealer.</li> <li>• If the power supply cord is damaged, it must be replaced by the manufacturer or its service agent in order to avoid a hazard.</li> </ul>
	<p><b>When installing, relocating, or servicing the unit, make sure that no substance other than the specified refrigerant (R32) enters the refrigerant circuit.</b></p> <ul style="list-style-type: none"> <li>• Any presence of foreign substance such as air can cause abnormal pressure rise and may result in explosion or injury.</li> <li>• The use of any refrigerant other than that specified for the system will cause mechanical failure, system malfunction, or unit breakdown. In the worst case, this could lead to a serious impediment to securing product safety.</li> </ul>
	<p><b>This appliance is not intended for use by persons (including children) with reduced physical, sensory or mental capabilities, or lack of experience and knowledge, unless they have been given supervision or instruction concerning use of the appliance by a person responsible for their safety.</b></p>
	<p><b>Children should be supervised to ensure that they do not play with the appliance.</b></p>
 	<p><b>Do not insert your finger, a stick, or other objects into the air inlet or outlet.</b></p> <ul style="list-style-type: none"> <li>• This may cause injury, since the fan inside rotates at high speeds during operation.</li> </ul>

 	<p><b>In case of an abnormal condition (such as a burning smell), stop the air conditioner and disconnect the power plug or turn the breaker OFF.</b></p> <ul style="list-style-type: none"> <li>• A continued operation in the abnormal state may cause a malfunction, fire, or electric shock. In this case, consult your dealer.</li> </ul>
 	<p><b>When the air conditioner does not cool or heat, there is a possibility of refrigerant leakage. If any refrigerant leakage is found, stop operations and ventilate the room well and consult your dealer immediately. If a repair involves recharging the unit with refrigerant, ask the service technician for details.</b></p> <ul style="list-style-type: none"> <li>• The refrigerant used in the air conditioner is not harmful. Normally, it does not leak. However, if refrigerant leaks and comes in contact with fire or heating part of such a fan heater, kerosene heater, or cooking stove, it will create harmful gas and there is risk of fire.</li> </ul>
	<p><b>The user should never attempt to wash the inside of the indoor unit. Should the inside of the unit require cleaning, contact your dealer.</b></p> <ul style="list-style-type: none"> <li>• Unsuitable detergent may cause damage to plastic material inside the unit, which may result in water leakage. Should detergent come in contact with electrical parts or the motor, it will result in a malfunction, smoke, or fire.</li> <li>• The appliance shall be stored in a room without continuously operating ignition sources (for example: open flames, an operating gas appliance or an operating electric heater).</li> <li>• Be aware that refrigerants may not contain an odour.</li> <li>• Do not use means to accelerate the defrosting process or to clean the appliance, other than those recommended by the manufacturer.</li> <li>• Do not pierce or burn.</li> </ul>
	<p><b>The indoor unit must be installed in rooms which exceed the floor space specified. Please consult your dealer.</b></p> <ul style="list-style-type: none"> <li>• AP50: 1.9 m<sup>2</sup></li> </ul>
	<p><b>This appliance is intended to be used by expert or trained users in shops, in light industry and on farms, or for commercial use by lay persons.</b></p>
<b>CAUTION</b>	
	<p><b>Do not touch the air inlet or the aluminum fins of the indoor/outdoor unit.</b></p> <ul style="list-style-type: none"> <li>• This may cause injury.</li> </ul>
	<p><b>Do not use insecticides or flammable sprays on the unit.</b></p> <ul style="list-style-type: none"> <li>• This may cause a fire or deformation of the unit.</li> </ul>
	<p><b>Do not expose pets or houseplants to direct airflow.</b></p> <ul style="list-style-type: none"> <li>• This may cause injury to the pets or plants.</li> </ul>

# SAFETY PRECAUTIONS

EN





	<p><b>Do not place other electric appliances or furniture under the indoor/outdoor unit.</b></p> <ul style="list-style-type: none"> <li>Water may drip down from the unit, which may cause damage or malfunction.</li> </ul>
	<p><b>Do not leave the unit on a damaged installation stand.</b></p> <ul style="list-style-type: none"> <li>The unit may fall and cause injury.</li> </ul>
	<p><b>Do not step on an unstable bench to operate or clean the unit.</b></p> <ul style="list-style-type: none"> <li>This may cause injury if you fall down.</li> </ul>
	<p><b>Do not pull the power cord.</b></p> <ul style="list-style-type: none"> <li>This may cause a portion of the core wire to break, which may cause overheating or fire.</li> </ul>
	<p><b>Do not charge or disassemble the batteries, and do not throw them into a fire.</b></p> <ul style="list-style-type: none"> <li>This may cause the batteries to leak, or cause a fire or explosion.</li> </ul>
	<p><b>Do not operate the unit for more than 4 hours at high humidity (80% RH or more) and/or with windows or outside door left open.</b></p> <ul style="list-style-type: none"> <li>This may cause the water condensation in the air conditioner, which may drip down, wetting or damaging the furniture.</li> <li>The water condensation in the air conditioner may contribute to growth of fungi, such as mold.</li> </ul>
	<p><b>Do not use the unit for special purposes, such as storing food, raising animals, growing plants, or preserving precision devices or art objects.</b></p> <ul style="list-style-type: none"> <li>This may cause deterioration of quality, or harm to animals and plants.</li> </ul>
	<p><b>Do not expose combustion appliances to direct airflow.</b></p> <ul style="list-style-type: none"> <li>This may cause incomplete combustion.</li> </ul>
	<p><b>Never put batteries in your mouth for any reason to avoid accidental ingestion.</b></p> <ul style="list-style-type: none"> <li>Battery ingestion may cause choking and/or poisoning.</li> </ul>
	<p><b>Before cleaning the unit, switch it OFF and disconnect the power plug or turn the breaker OFF.</b></p> <ul style="list-style-type: none"> <li>This may cause injury, since the fan inside rotates at high speeds during operation.</li> </ul>
	<p><b>When the unit will be unused for a long time, disconnect the power plug or turn the breaker OFF.</b></p> <ul style="list-style-type: none"> <li>The unit may accumulate dirt, which may cause overheating or fire.</li> </ul>
	<p><b>Replace all batteries of the remote controller with new ones of the same type.</b></p> <ul style="list-style-type: none"> <li>Using an old battery together with a new one may cause overheating, leakage, or explosion.</li> </ul>
	<p><b>If the battery fluid comes in contact with your skin or clothes, wash them thoroughly with clean water.</b></p> <ul style="list-style-type: none"> <li>If the battery fluid comes in contact with your eyes, wash them thoroughly with clean water and immediately seek medical attention.</li> </ul>
	<p><b>Ensure that the area is well-ventilated when the unit is operated together with a combustion appliance.</b></p> <ul style="list-style-type: none"> <li>Inadequate ventilation may cause oxygen starvation.</li> </ul>
	<p><b>Turn the breaker OFF when you hear thunder and there is a possibility of a lightning strike.</b></p> <ul style="list-style-type: none"> <li>The unit may be damaged if lightning strikes.</li> </ul>
	<p><b>After the air conditioner is used for several seasons, perform inspection and maintenance in addition to normal cleaning.</b></p> <ul style="list-style-type: none"> <li>Dirt or dust in the unit may create an unpleasant odor, contribute to growth of fungi, such as mold, or clog the drain passage, and cause water to leak from the indoor unit. Consult your dealer for inspection and maintenance, which require specialized knowledge and skills.</li> </ul>
	<p><b>Do not operate switches with wet hands.</b></p> <ul style="list-style-type: none"> <li>This may cause electric shock.</li> </ul>
	<p><b>Do not clean the air conditioner with water or place an object that contains water, such as a flower vase, on it.</b></p> <ul style="list-style-type: none"> <li>This may cause fire or electric shock.</li> </ul>
	<p><b>Do not step on or place any object on the outdoor unit.</b></p> <ul style="list-style-type: none"> <li>This may cause injury if you or the object falls down.</li> </ul>

## IMPORTANT

Dirty filters cause condensation in the air conditioner which will contribute to the growth of fungi such as mold. It is therefore recommended to clean air filters every 2 weeks.

Before starting the operation, ensure that the horizontal vanes are in the closed position. If operation starts when the horizontal vanes are in the open position, they may not return to the correct position.







## For installation

 <b>WARNING</b>	
	<p><b>Consult your dealer for installing the air conditioner.</b></p> <ul style="list-style-type: none"> <li>It should not be installed by the user since installation requires specialized knowledge and skills. An improperly installed air conditioner may cause water leakage, fire, or electric shock.</li> </ul>
	<p><b>Provide a dedicated power supply for the air conditioner.</b></p> <ul style="list-style-type: none"> <li>A non-dedicated power supply may cause overheating or fire.</li> </ul>
	<p><b>Do not install the unit where flammable gas could leak.</b></p> <ul style="list-style-type: none"> <li>If gas leaks and accumulates around the outdoor unit, it may cause an explosion.</li> </ul>
	<p><b>Earth the unit correctly.</b></p> <ul style="list-style-type: none"> <li>Do not connect the earth wire to a gas pipe, water pipe, lightning rod, or a telephone earth wire. Improper earthing may cause electric shock.</li> </ul>
 <b>CAUTION</b>	
	<p><b>Install an earth leakage breaker depending on the installation location of the air conditioner (such as highly humid areas).</b></p> <ul style="list-style-type: none"> <li>If an earth leakage breaker is not installed, it may cause electric shock.</li> </ul>
	<p><b>Ensure that the drain water is properly drained.</b></p> <ul style="list-style-type: none"> <li>If the drain passage is improper, water may drip down from the indoor/outdoor unit, wetting and damaging the furniture.</li> </ul>

### In case of an abnormal condition

Immediately stop operating the air conditioner and consult your dealer.

## For Wi-Fi interface

 <b>WARNING</b>	
(Improper handling may have serious consequences, including serious injury or death.)	
	<p>This appliance can be used by children aged from 8 years and above and persons with reduced physical, sensory or mental capabilities or lack of experience and knowledge if they have been given supervision or instruction concerning use of the appliance in a safe way and understand the hazards involved.</p>
	<p>Children shall not play with the appliance. Cleaning and user maintenance shall not be made by children without supervision.</p>
	<p><b>Do not use the Wi-Fi interface nearby the medical electrical equipment or people who have a medical device such as a cardiac pacemaker or an implantable cardioverter-defibrillator.</b></p> <ul style="list-style-type: none"> <li>It can cause an accident due to malfunctions of the medical equipment or device.</li> </ul>
	<p><b>Do not install the Wi-Fi interface nearby the automatic control devices such as automatic doors or fire alarms.</b></p> <ul style="list-style-type: none"> <li>It can cause accidents due to malfunctions.</li> </ul>
	<p><b>Do not touch the Wi-Fi interface with wet hands.</b></p> <ul style="list-style-type: none"> <li>It can cause damage to the device, electric shock, or fire.</li> </ul>
	<p><b>Do not splash water on the Wi-Fi interface or use it in a bathroom.</b></p> <ul style="list-style-type: none"> <li>It can cause damage to the device, electric shock, or fire.</li> </ul>
	<p><b>When the Wi-Fi interface is dropped, or the holder or cable is damaged, disconnect the power supply plug or turn the breaker OFF.</b></p> <ul style="list-style-type: none"> <li>It may cause fire or electric shock. In this case, consult your dealer.</li> </ul>
 <b>CAUTION</b>	
(Improper handling may have consequences, including injury or damage to building.)	
	<p><b>Do not step on unstable stepstool to set up or clean the Wi-Fi interface.</b></p> <ul style="list-style-type: none"> <li>It may cause injury if you fall down.</li> </ul>
	<p><b>Do not use the Wi-Fi interface nearby other wireless devices, microwaves, cordless phones, or facsimiles.</b></p> <ul style="list-style-type: none"> <li>It can cause malfunctions.</li> </ul>

# DISPOSAL



Fig. 1

To dispose of this product, consult your dealer.

## Note:

This symbol mark is for EU countries only.  
This symbol mark is according to the directive 2012/19/EU Article 14 Information for users and Annex IX, and/or to the directive 2006/66/EC Article 20 Information for end-users and Annex II.

Your MITSUBISHI ELECTRIC product is designed and manufactured with high quality materials and components which can be recycled and/or reused. This symbol means that electrical and electronic equipment, batteries and accumulators, at their end-of-life, should be disposed of separately from your household waste.

If a chemical symbol is printed beneath the symbol (Fig. 1), this chemical symbol means that the battery or accumulator contains a heavy metal at a certain concentration. This will be indicated as follows:

Hg: mercury (0.0005%), Cd: cadmium (0.002%), Pb: lead (0.004%)

In the European Union there are separate collection systems for used electrical and electronic products, batteries and accumulators.

Please, dispose of this equipment, batteries and accumulators correctly at your local community waste collection/recycling centre.

Please, help us to conserve the environment we live in!

# NAME OF EACH PART

## Indoor unit

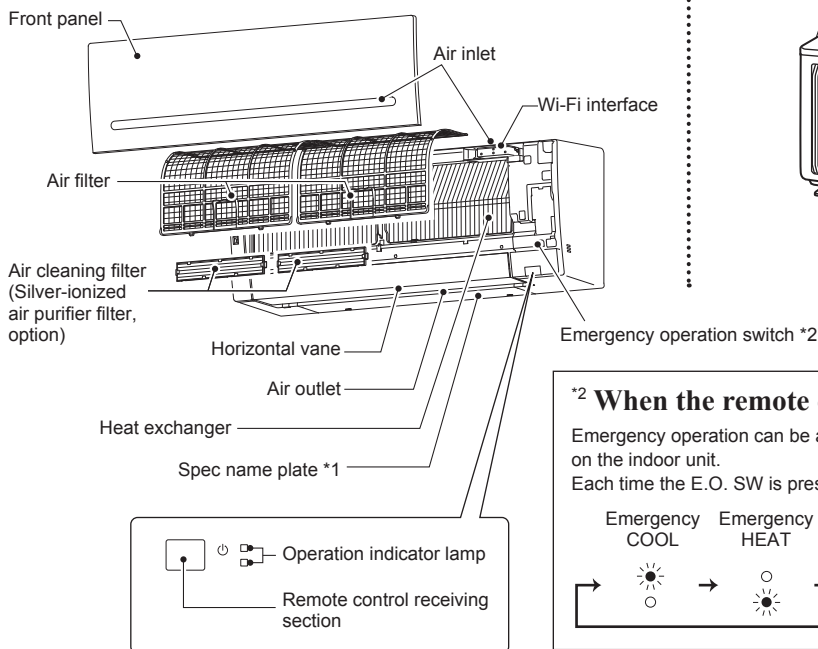

## Outdoor unit

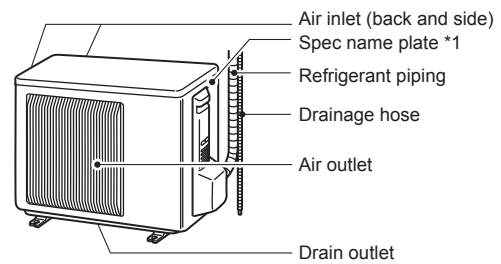

Outdoor units may be different in appearance.

\*1 The manufacturing year and month are indicated on the spec name plate.

### \*2 When the remote controller cannot be used...

Emergency operation can be activated by pressing the emergency operation switch (E.O. SW) on the indoor unit.

Each time the E.O. SW is pressed, the operation changes in the following order:

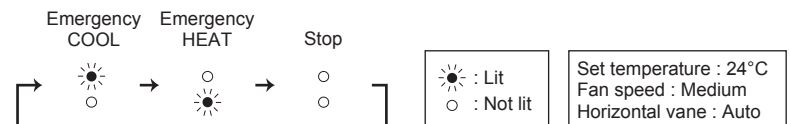

# PREPARATION BEFORE OPERATION

**Before operation:** Insert the power supply plug into the power outlet and/or turn the breaker on.

## Installing the remote controller batteries

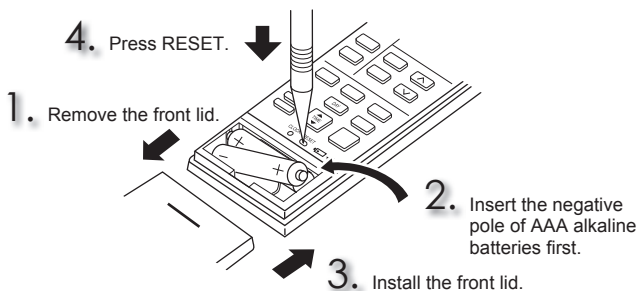

## Setting current time

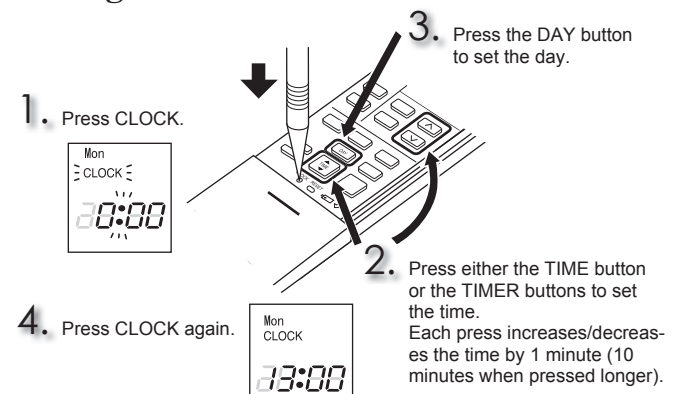

# PREPARATION BEFORE OPERATION

## Remote controller

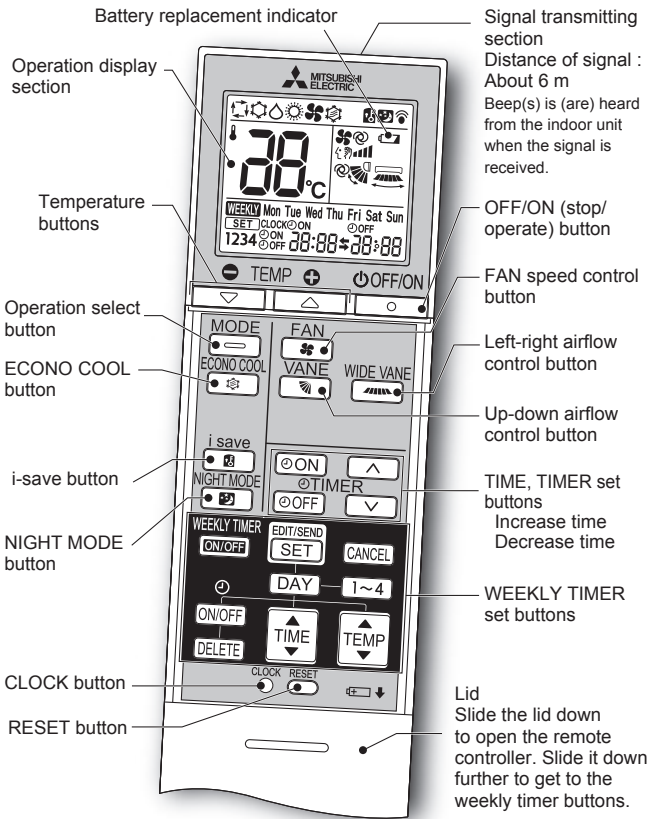

**OFF/ON**  
 OFF/ON (stop/operate) button

**MODE**  
 Operation select button

**Temperature buttons**  
 Each press raises or lowers the temperature by 1°C.

**FAN**  
 FAN speed control button

**WIDE VANE**  
 Left-right airflow control button

**VANE**  
 Up-down airflow control button

**ECONO COOL**  
 ECONO COOL button

The set temperature and the airflow direction are automatically changed by the microprocessor.

**i save**  
 i-save button

A simplified set back function enables to recall the preferred (preset) setting with a single push of the button. Press the button again and you can go back to the previous setting in an instance.

**NIGHT MODE**  
 NIGHT MODE button

NIGHT MODE operation changes the brightness of the operation indicator, disables the beep sound and limits the noise level of the outdoor unit.

## TIME, TIMER set button

Increase time Decrease time  
 (ON timer) : The unit turns ON at the set time.  
 (OFF timer) : The unit turns OFF at the set time.

Press (Increase) and (Decrease) to set the time of timer.

## WEEKLY TIMER set buttons

Press to enter the weekly timer setting mode.

Press and to select setting day and number.



Press , , and to set ON/OFF, time, and temperature.

Press to complete and transmit the weekly timer setting.

Press to turn the weekly timer ON. ( **WEEKLY** lights.)

Press again to turn the weekly timer OFF. ( **WEEKLY** goes out.)

# CLEANING

## Instructions:

- Switch off the power supply or turn off the breaker before cleaning.
- Be careful not to touch the metal parts with your hands.
- Do not use benzene, thinner, polishing powder, or insecticide.
- Use only diluted mild detergents.
- Do not use a scrubbing brush, a hard sponge, or the like.
- Do not soak or rinse the horizontal vane.
- Do not use water hotter than 50°C.
- Do not expose parts to direct sunlight, heat, or fire to dry.
- Do not apply excessive force on the fan as it may cause cracks or breakage.

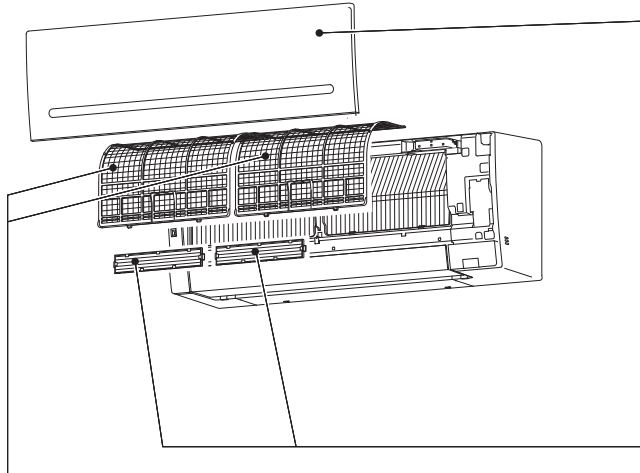

## Front panel

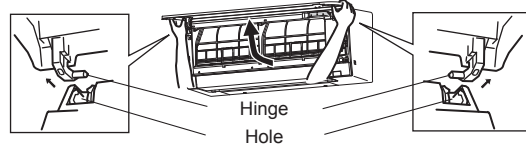

1. Lift the front panel until a "click" is heard.
2. Hold the hinges and pull to remove as shown in the illustration above.
  - Wipe with a soft dry cloth or rinse it with water.
  - Do not soak it in water for more than two hours.
  - Dry it well in shade before installing it.
3. Install the front panel by following the removal procedure in reverse. Close the front panel securely and press the positions indicated by the arrows.



## Air filter (Air purifying filter)

- **Clean every 2 weeks**
- Remove dirt by a vacuum cleaner, or rinse with water.
- After washing with water, dry it well in shade.

### Important

- **Clean the filters regularly for best performance and to reduce power consumption.**
- **Dirty filters cause condensation in the air conditioner which will contribute to the growth of fungi such as mold. It is therefore recommended to clean air filters every 2 weeks.**

## Air cleaning filter (Silver-ionized air purifier filter, option)

### Every 3 months:

- Remove dirt by a vacuum cleaner.

### When dirt cannot be removed by vacuum cleaning:

- Soak the filter and its frame in lukewarm water before rinsing it.
- After washing, dry it well in shade. Install all tabs of the air filter.

### Every year:

- Replace it with a new air cleaning filter for best performance.
- Parts Number **MAC-2370FT-E**

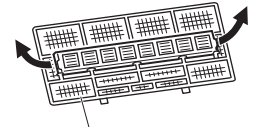

Pull to remove from the air filter

This information is based on **REGULATION (EU) No 528/2012**

MODEL NAME	Treated Article (Parts name)	Active Substances (CAS No.)	Property	Instruction for Use (Safe handling information)
MSZ-AP25/35/42/50VG	FILTER	Silver sodium hydrogen zirconium phosphate (265647-11-8) 2-octyl-2H-isothiazol-3-one (OIT) (26530-20-1)	Antibacterial Antimold	<ul style="list-style-type: none"> <li>• Use this product in line with the instruction manual indications and for the intended purpose only.</li> <li>• Do not put into mouth. Keep away from children.</li> </ul>
MAC-2370FT-E	FILTER	Silver zinc zeolite (130328-20-0)	Antibacterial	<ul style="list-style-type: none"> <li>• Use this product in line with the instruction manual indications and for the intended purpose only.</li> <li>• Do not put into mouth. Keep away from children.</li> </ul>

# Wi-Fi INTERFACE SETTING UP (VGK type only)

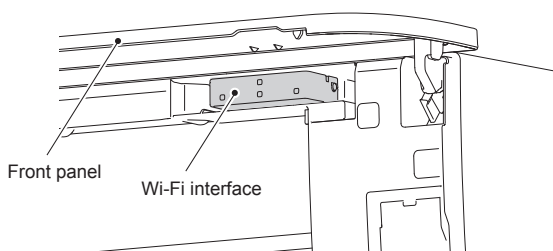

This Wi-Fi interface, communicates the status information and controls the commands from the MELCloud by connecting to the indoor unit.

### Note:

- Set up a connection between the Wi-Fi interface and the Router. Refer to the SETUP MANUAL and SETUP QUICK REFERENCE GUIDE provided with the unit.
- For SETUP MANUAL, please go to the website below.  
<http://www.melcloud.com/Support>
- For MELCloud User Manual, please go to the website below.  
<http://www.melcloud.com/Support>

# SPECIFICATIONS

Model	Indoor		MSZ-AP25VG(K)		MSZ-AP35VG(K)		MSZ-AP42VG(K)		MSZ-AP50VG(K)	
	Outdoor		MUZ-AP25VG(H)		MUZ-AP35VG(H)		MUZ-AP42VG(H)		MUZ-AP50VG(H)	
Function			Cooling	Heating	Cooling	Heating	Cooling	Heating	Cooling	Heating
Power supply			~ /N, 230 V, 50 Hz							
Capacity		kW	2.5	3.2	3.5	4.0	4.2	5.4	5.0	5.8
Input		kW	0.60	0.78	0.99	1.03	1.30	1.49	1.55	1.60
Weight	Indoor	kg	10.5							
	Outdoor	kg	31		31		35		40	
Refrigerant filling capacity (R32)		kg	0.55		0.55		0.70		1.00	
IP code	Indoor		IP 20							
	Outdoor		IP 24							
Permissible excessive operating pressure	LP ps	MPa	2.77							
	HP ps	MPa	4.17							
Noise level (SPL)	Indoor (Super High/High/Med./Low/Silent)	dB(A)	42/36/30/24/19	45/38/31/24/19	42/36/30/24/19	45/38/31/24/19	42/38/34/29/21	45/40/35/29/21	44/40/36/33/28	48/43/38/33/28
	Outdoor	dB(A)	47	48	49	50	50	51	52	52

## Indoor specification for multi connection REGULATION (EU) 2016/2281

Model	Indoor			MSZ-AP25VG(K)	MSZ-AP35VG(K)	MSZ-AP42VG(K)	MSZ-AP50VG(K)
Capacity	Cooling	Sensible	kW	2.30	3.08	3.23	3.70
		Latent	kW	0.20	0.42	0.97	1.30
	Heating		kW	2.90	4.00	4.80	5.70
Input			kW	0.026	0.026	0.032	0.032
Noise level (Sound power level)	Super High/High/Med./Low/Silent		dB(A)	57/51/45/39/34	57/51/45/39/34	57/53/49/44/36	58/54/50/47/42

## Guaranteed operating range

		Indoor	Outdoor	
			MUZ-AP25/35/42/50VG	MUZ-AP25/35/42/50VGH
Cooling	Upper limit	32°C DB 23°C WB	46°C DB —	46°C DB —
	Lower limit	21°C DB 15°C WB	-10°C DB —	-10°C DB —
Heating	Upper limit	27°C DB —	24°C DB 18°C WB	24°C DB 18°C WB
	Lower limit	20°C DB —	-15°C DB -16°C WB	-20°C DB -21°C WB

### Note:

Rating condition  
 Cooling — Indoor: 27°C DB, 19°C WB  
           Outdoor: 35°C DB  
 Heating — Indoor: 20°C DB  
           Outdoor: 7°C DB, 6°C WB

DB: Dry Bulb  
 WB: Wet Bulb

## Wi-Fi interface

Model	MAC-566IFB-E
Input Voltage	DC12.7 V (from indoor unit)
Power consumption	MAX. 2 W
Size H×W×D (mm)	79×44×18.5
Weight (g)	60 (including cable)
Transmitter power level (MAX.)	17.5 dBm @IEEE 802.11b
RF channel	1ch ~ 13ch (2412~2472 MHz)
Radio protocol	IEEE 802.11b/g/n (20)
Encryption	AES
Authentication	WPA2-PSK
Software Version	XX.00

For Declaration of Conformity, please go to the website below.  
<http://www.melcloud.com/Support>

## WHEN YOU THINK THAT TROUBLE HAS OCCURRED

In the following cases, stop using the air conditioner and consult your dealer.

- When water leaks or drips from the indoor unit.
- When the operation indicator lamp blinks.
- When the breaker trips frequently.
- The remote control signal is not received in a room where an electronic ON/OFF type fluorescent lamp (inverter-type fluorescent lamp, etc.) is used.
- Operation of the air conditioner interferes with radio or TV reception. An amplifier may be required for the affected device.
- When an abnormal sound is heard.
- When any refrigerant leakage is found.